

P-Channel MOSFET

2SJ603-ZJ

■ Features

- $V_{DS} = -60V$
- $I_D = -25A$
- $R_{DS(ON)} < 48m\Omega$ ($V_{GS} = -10V$)
- $R_{DS(ON)} < 75m\Omega$ ($V_{GS} = -4V$)
- Low Ciss: Ciss = 1900 pF (TYP.)

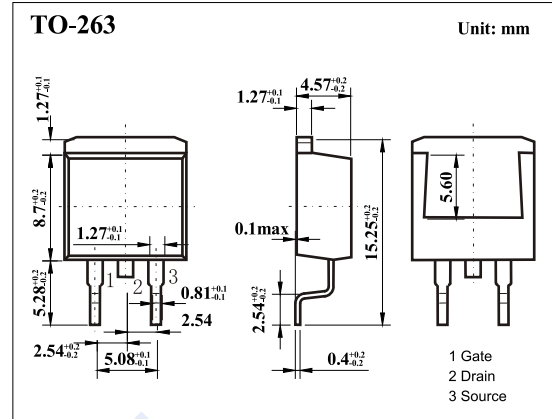
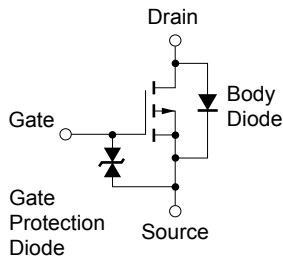

■ Absolute Maximum Ratings $T_a = 25^\circ C$

Parameter	Symbol	Rating	Unit	
Drain-Source Voltage	V_{DS}	-60	V	
Gate-Source Voltage	V_{GS}	± 20		
Continuous Drain Current	I_D	-25	A	
Pulsed Drain Current (Note.1)	I_{DM}	-70		
Single Avalanche Current (Note.2)	I_{AS}	-25		
Power Dissipation	P_D	$T_c = 25^\circ C$	50	W
		$T_a = 25^\circ C$	1.5	
Single Avalanche Energy (Note.2)	E_{AS}	62.5	mJ	
Junction Temperature	T_J	150	$^\circ C$	
Junction Storage Temperature Range	T_{stg}	-55 to 150		

Note.1: $PW \leq 10\mu s$, Duty Cycle $\leq 1\%$

Note.2: Starting $T_J = 25^\circ C$, $V_{DD} = -30V$, $R_G = 25\Omega$, $V_{GS} = -20V \rightarrow 0$

P-Channel MOSFET

2SJ603-ZJ

Typical Characteristics

Parameter	Symbol	Test Conditions	Min	Typ	Max	Unit
Drain-Source Breakdown Voltage	V_{DS}	$I_D = -250 \mu A, V_{GS} = 0V$	-60			V
Zero Gate Voltage Drain Current	I_{DSS}	$V_{DS} = -60V, V_{GS} = 0V$			-10	μA
Gate-Body leakage current	I_{GSS}	$V_{DS} = 0V, V_{GS} = \pm 20V$			± 10	μA
Gate Cut off Voltage	$V_{GS(off)}$	$V_{DS} = -10V, I_D = -1mA$	-1.5		-2.5	V
Static Drain-Source On-Resistance	$R_{DS(on)}$	$V_{GS} = -10V, I_D = -13A$			48	$m\Omega$
		$V_{GS} = -4V, I_D = -13A$			75	
Forward Transconductance	g_{FS}	$V_{DS} = -10V, I_D = -13A$	10	21		S
Input Capacitance	C_{iss}	$V_{GS} = 0V, V_{DS} = -10V, f = 1MHz$		1900		pF
Output Capacitance	C_{oss}			350		
Reverse Transfer Capacitance	C_{rss}			140		
Total Gate Charge	Q_g			38		
Gate Source Charge	Q_{gs}	$V_{GS} = -10V, V_{DS} = -48V, I_D = -25A$		7		nC
Gate Drain Charge	Q_{gd}			10		
Turn-On Delay Time	$t_{d(on)}$			10		
Turn-On Rise Time	t_r	$V_{GS(on)} = -10V, V_{DS} = -30V, I_D = -13A, R_G = 0 \Omega$		11		ns
Turn-Off Delay Time	$t_{d(off)}$			66		
Turn-Off Fall Time	t_f			20		
Body Diode Reverse Recovery Time	t_{rr}			49		
Body Diode Reverse Recovery Charge	Q_{rr}	$I_F = -25A, V_{GS} = 0, di/dt = 100A/\mu s$		100		nC
Diode Forward Voltage	V_{SD}	$I_F = -25A, V_{GS} = 0V$		-1		V

Typical Characteristics

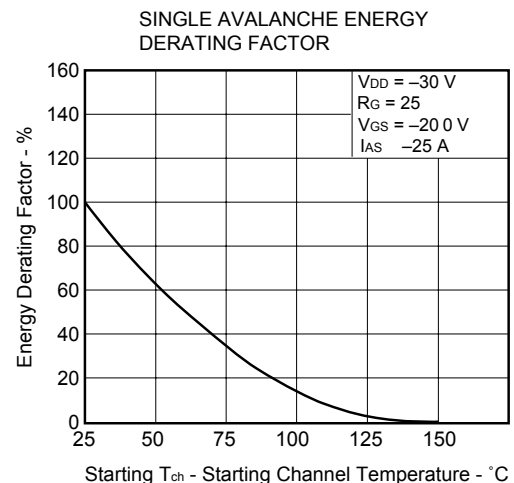
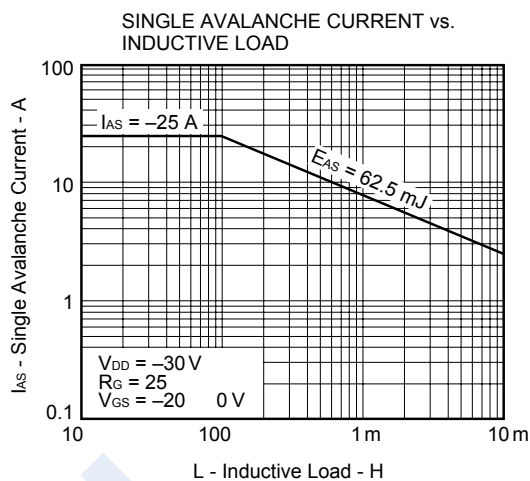

P-Channel MOSFET 2SJ603-ZJ

Typical Characteristics

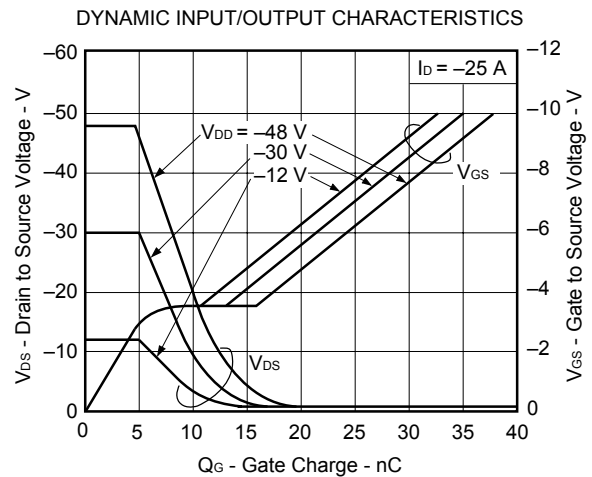
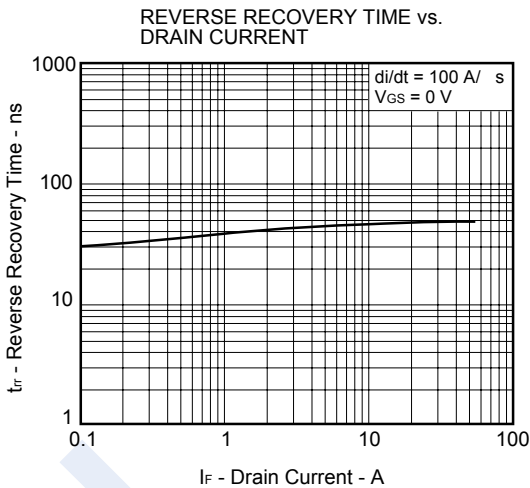
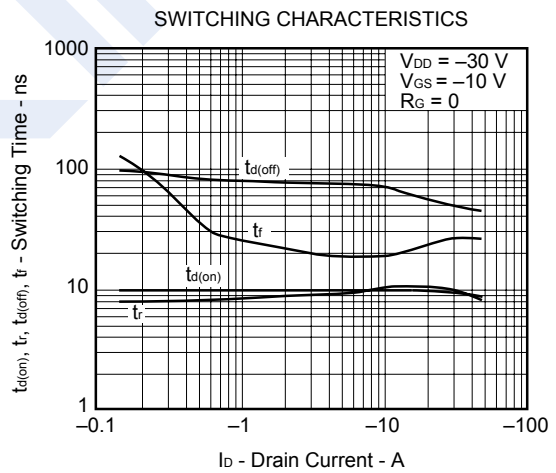
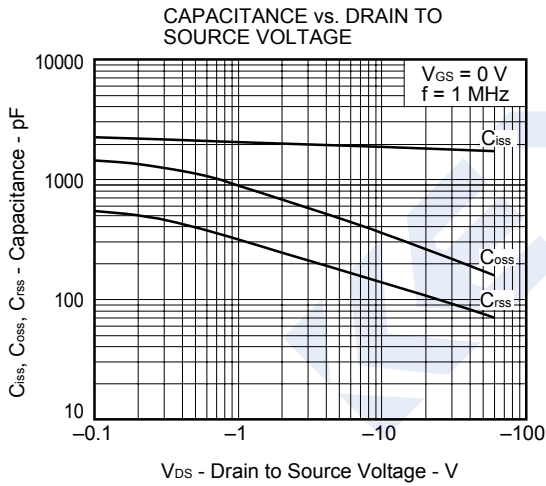
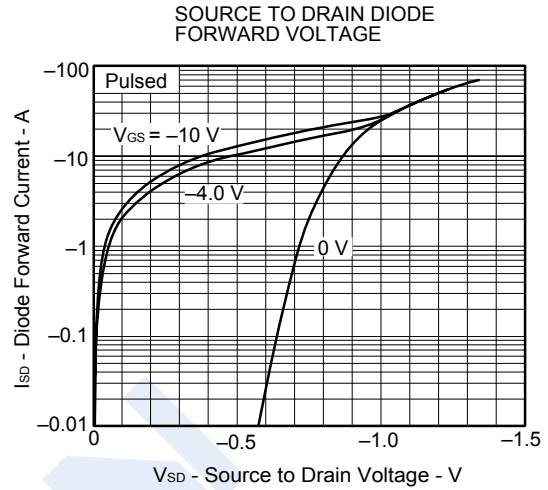
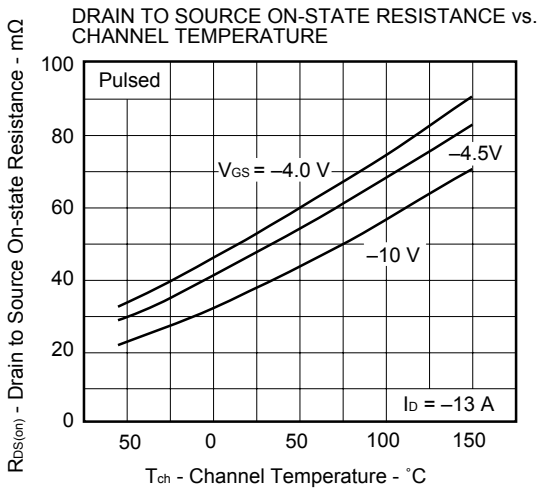

P-Channel MOSFET 2SJ603-ZJ

■ Typical Characteristics

FORWARD TRANSFER CHARACTERISTICS

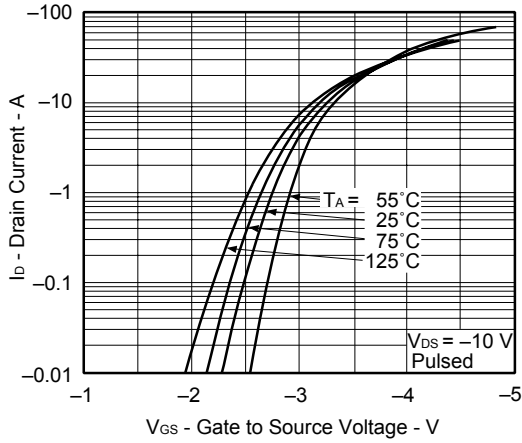

DRAIN CURRENT vs. DRAIN TO SOURCE VOLTAGE

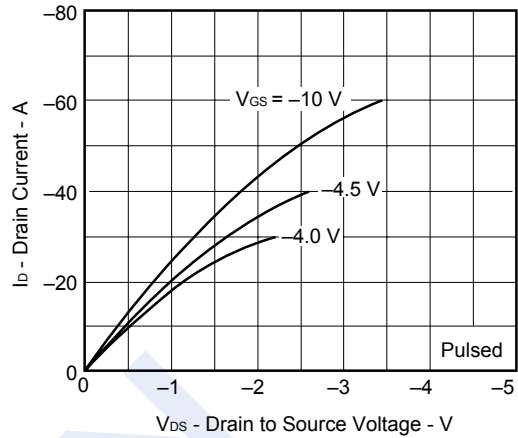

FORWARD TRANSFER ADMITTANCE vs. DRAIN CURRENT

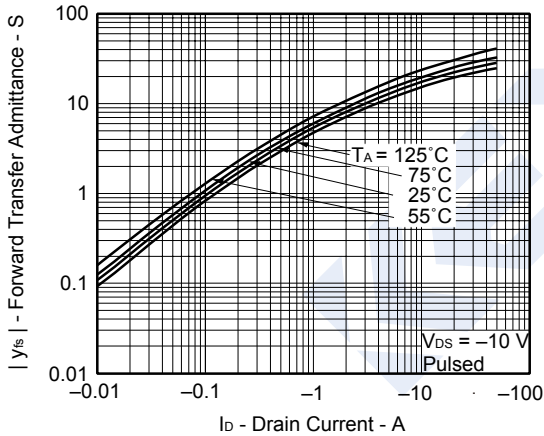

DRAIN TO SOURCE ON-STATE RESISTANCE vs. GATE TO SOURCE VOLTAGE

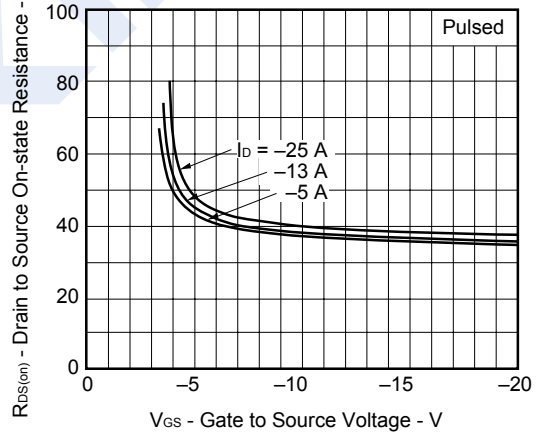

DRAIN TO SOURCE ON-STATE RESISTANCE vs. DRAIN CURRENT

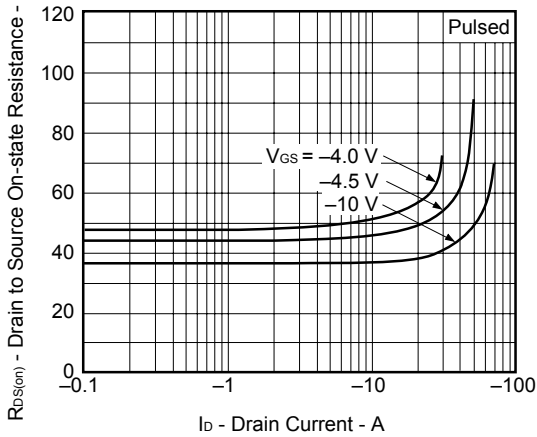

GATE CUT-OFF VOLTAGE vs. CHANNEL TEMPERATURE

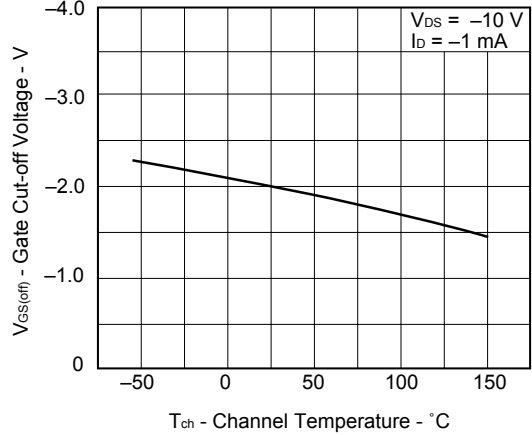

P-Channel MOSFET 2SJ603-ZJ

■ Typical Characteristics

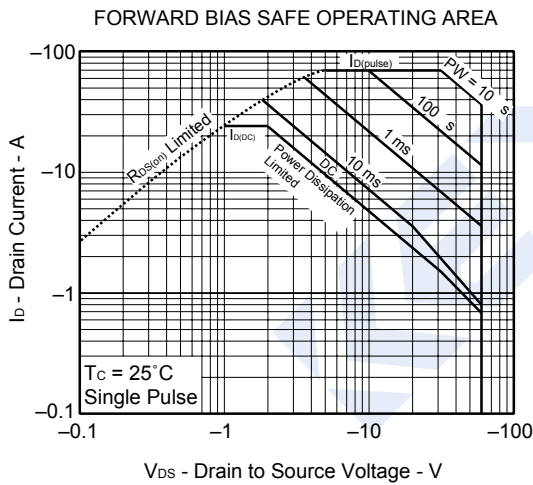
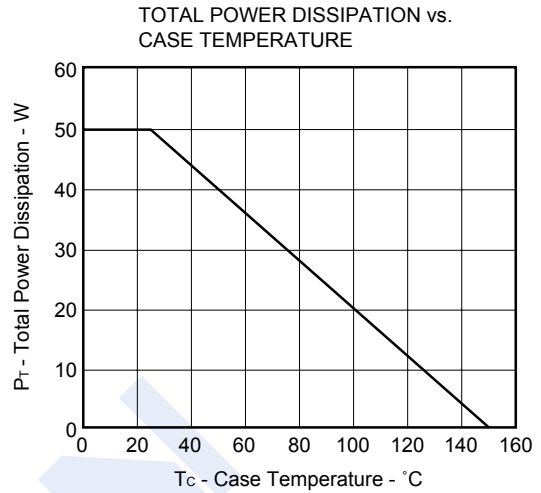
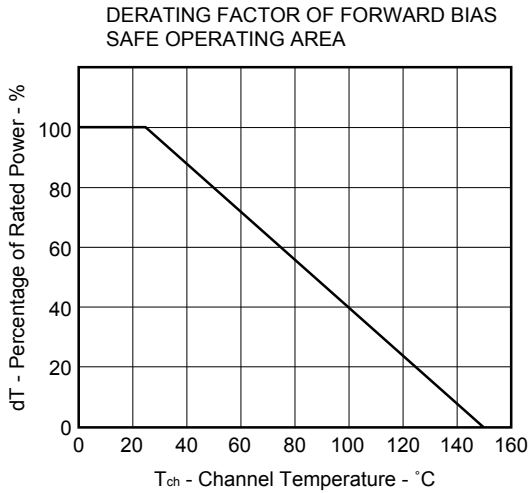

V_{DS} - Drain to Source Voltage - V

